

Price  
\$2.00

Bulletin No. 1-208  
Revision "E"

# OPERATORS MANUAL

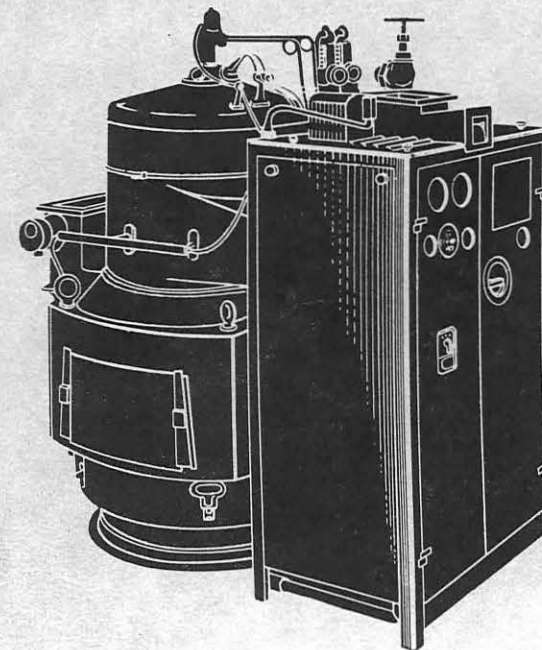

for

OK-4608

OK-4616

OK-4630

OK-4635

OK-4610

OK-4625

OK-4740

DSK-4530

VAPOR STEAM GENERATORS



6420 W. HOWARD ST., CHICAGO, 60648, U.S.A.

Transportation Systems Division 6420 West Howard Street, Chicago, 60648

Vapor Canada Limited, 3955 Courtrai Avenue, Montreal 26 Quebec

Vapor International Division, 6420 West Howard Street, Chicago, 60648

E.J. HELLESEN  
Svalevej 25, 2600 Glostrup  
Tlf. 42 96 03 73

*1 kg/cm<sup>2</sup> ~ 14,223 lbs/sq inch*

# OPERATORS MANUAL

for

VAPOR STEAM GENERATORS

OK-4616	OK-4630	OK-4635
OK-4625	OK-4740	DSK-4530



TRANSPORTATION SYSTEMS DIVISION

## STEAM GENERATORS

Operation of OK-4740 steam generators is similar to the other OK models with these exceptions:

1. The main switch-118 is mounted on the steam generator.
2. There are two line circuit breakers-116 and 117 and a rotary converter circuit breaker -115 instead of replaceable fuses.
3. A motor-215 and rotary converter-237 or static inverter are used instead of the single motor converter.
4. A worm drive assembly-236 is used instead of pulleys and belts.
5. The steam temperature limit control-110 (A-102228) has a manual reset button-110A that must be pushed in when the high temperature contacts of this control have shut down the steam generator.
6. The single stage electrical steam temperature limit control No. 45840033 is Standard on "OK" type steam generators after May 1959, except on OK 4740 units.

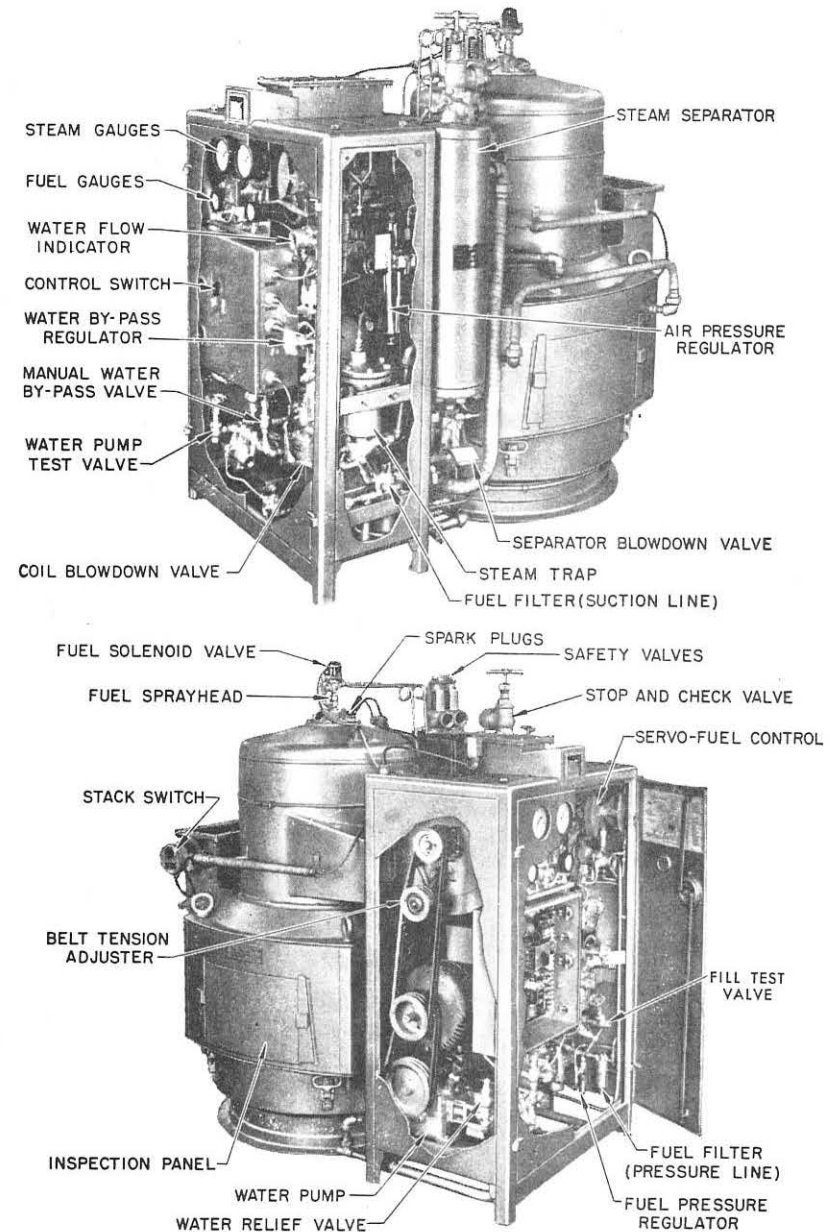

Fig. 1. OK-4625 Steam Generator.

OK-4616, OK-4625, OK-4630, OK-4635, OK-4740, DSK-4530

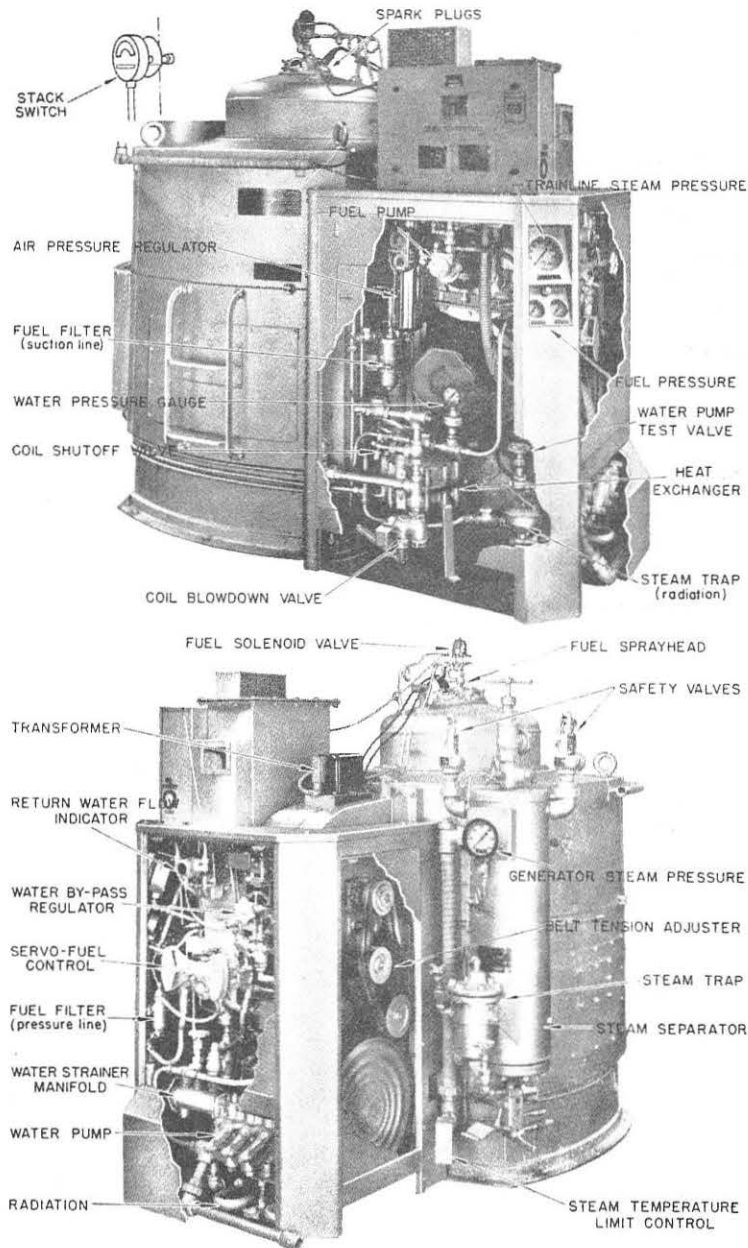

Fig. 2. OK-4630 or OK-4635 Type Steam Generator.

STEAM GENERATORS

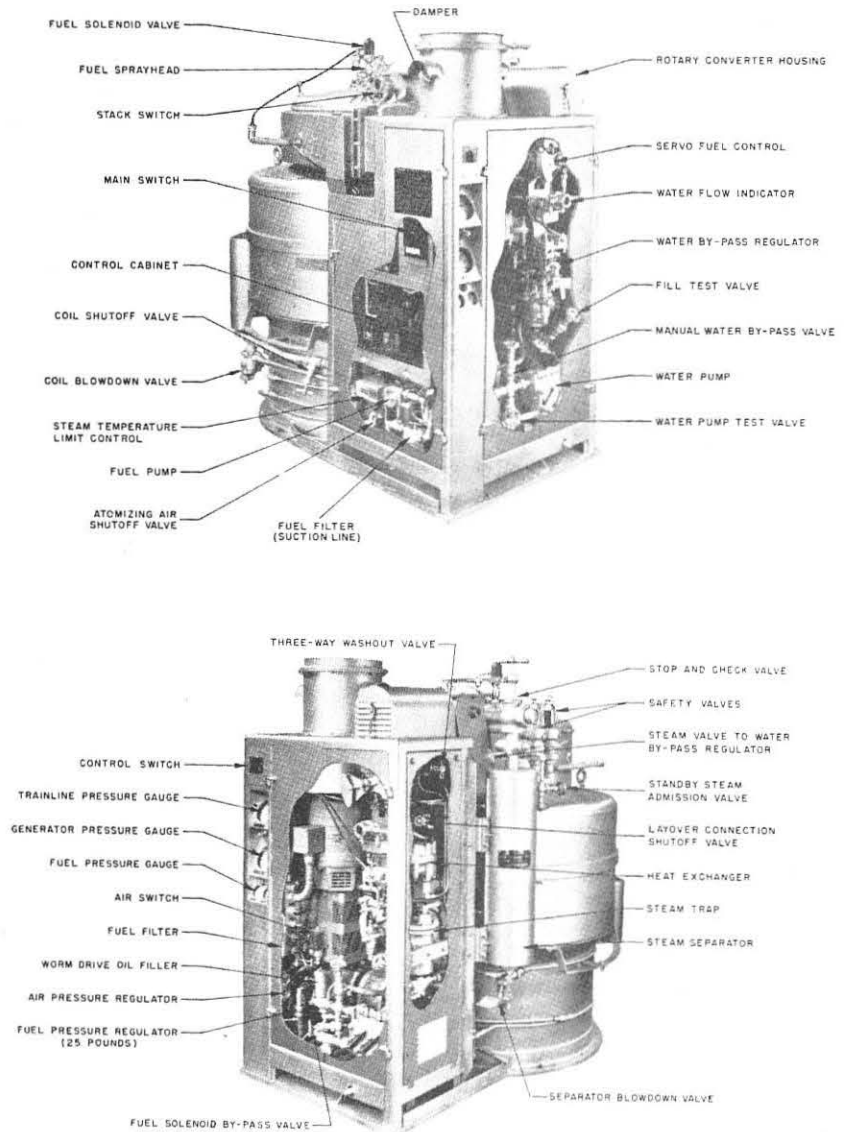

Fig. 3. OK-4740 Steam Generator.

### DESCRIPTION

Operation is completely automatic after the steam generator is started, and full operating steam pressure is reached within a few minutes.

The steam generating part of the unit consists of sets of coiled water tubing, nested and connected in series to form a single tube several hundred feet long. Water is pumped into the coil inlet and converted to steam as it progresses through the coils. Heat is furnished by the combustion of diesel fuel oil, which is sprayed by compressed air through the atomizing nozzle in the fuel spray head-105 into the firepot above the coils. Here the fine oil spray mixes with air supplied by the blower-202, and is ignited by a continuous electric spark-220. The fire and hot gases flow, first downward, then outward through the nest of coils.

The supply of fuel is regulated to evaporate 90% to 95% of the water pumped through the coils. The excess water flushes scale and sludge from the coils and is carried over with the steam into the steam separator-221, where the water and sludge are removed before the steam flows into the trainline.

The excess water collects in the bottom of the steam separator. Water above the level of the return outlet flows out through a steam trap-223 and through the heat exchanger-213, where it gives up its heat to the incoming feed water. From the heat exchanger the return water flows back to the water supply tank-232.

The motor-215 drives the blower-202, water pump-230 and fuel pump-209 at a constant speed. The water by-pass regulator-111 automatically controls the steam generator output by regulating the amount of water fed to the coils. Before entering the coils, the water passes through the servo-fuel control-108, which admits fuel to the spray nozzle in direct proportion to the amount of water entering the coils. The servo-fuel control also adjusts the damper-203 to admit the proper amount of air for efficient combustion of the fuel.

The trainline steam pressure is regulated by adjusting the handwheel on the water by-pass regulator-111. The length of train and the weather conditions determine the setting.

### BEFORE STARTING

On OK models, the valves designated by **odd** numbers must be OPEN during normal operation of the steam generator. Valves designated by **even** numbers must be CLOSED during normal operation of the steam generator. Normally open valves are fitted with a cross type handle; normally closed valves are fitted with the standard round handle. These designations apply only to the OK series steam generators.

1. The following valves must be OPEN during normal operation of the steam generator:
  - 1—Atomizing Air Shutoff Valve
  - 3—Coil Shutoff Valve
  - 7—Remote Control Trainline Shutoff Valve
  - 7α—Reset Lever
  - 9—Return Water Outlet Valve
  - 11—Steam Admission Valve to Trainline Pressure Gauge
  - 13—Steam Admission Valve to Water By-Pass Regulator
  - 15—Stop and Check Valve (Closed during start or shut down procedure)
  - 17—Three-Way Washout Valve
  - 19—Water By-Pass Regulator Shutoff Valve
  - 21—Water Supply Stop Valve
2. The following valves must be CLOSED during normal operation of the steam generator:
  - 2—Coil Blowdown Valve and Switch
  - 4—Fill-Test Valve
  - 6—Layover Connection Shutoff Valve
  - 8—Manual Water By-Pass Valve
  - 10—Steam Admission Valve to Radiation (Open in cold weather)
  - 12—Steam Separator Blowdown Valve
  - 14—Washout Inlet Valve
  - 16—Washout Inlet Valve
  - 18—Water Pump Test Valve
  - 20—Water Suction Drain Valve
  - 22—Water Treatment Tank Drain Valve
  - 56—Return Line Valve (Standby)

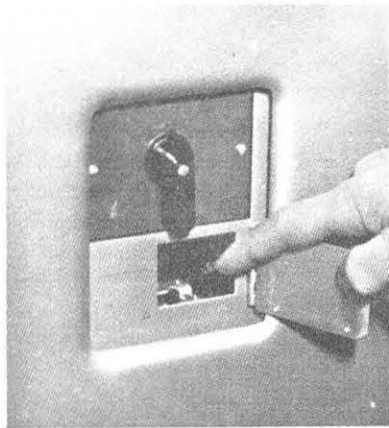

Fig. 4. Overload Reset Button.

On the OK-4740 units see that the steam temperature limit control reset button-110A is in.

On the OK-4740 units check to see that all the circuit breakers-115, 116 and 117 are closed.

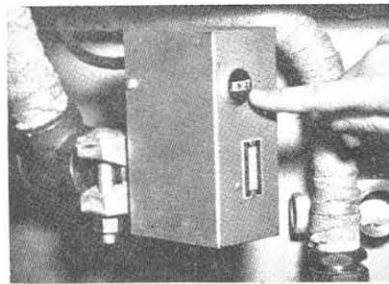

Fig. 6. Steam Temperature Limit Control Reset Button, OK-4740.

3. See that both the overload reset button-106 and the stack switch-109 reset button are "in." The overload reset button is located inside the control panel on the magnetic overload relay.

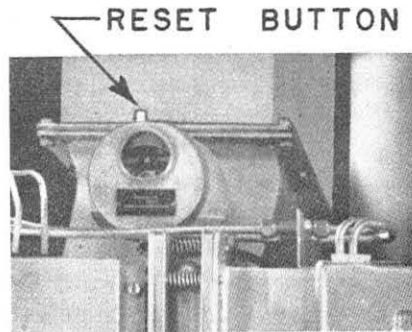

Fig. 5. Stack Switch Reset Button.

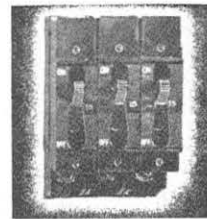

Fig. 7. Circuit Breakers, OK-4740

**TO FILL**

1. Open the atomizing air shutoff valve-1 and fill-test valve-4; latch open the separator blowdown valve-12 to drain the steam separator. Close the separator blowdown valve when the separator is completely drained.

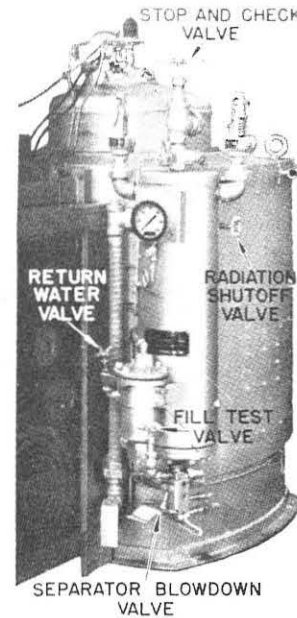

Fig. 8. Steam Separator on OK-4630

2. Close the main switch (On OK-4740 units, the main switch-118 is on the steam generator) and turn the control switch-102 to FILL.
3. While the coils are filling see that spark-220 is available for ignition. Check ALL valves.
4. When water discharges from the fill-test valve-4 turn the control switch-102 to OFF and close the fill-test valve.

**NOTE:** If the coils are empty it will take about five minutes to fill the steam generator with water.

On OK-4740 steam generators equipped with standby protection and on all 4740 units shipped after CD No. 10-17-51, the servo fuel control-108 will move only to one-third maximum travel.

**TO START**

**CAUTION:** Do not start the steam generator unless the coils are filled.

1. Latch open the separator blowdown valve-12 and turn the control switch-102 to RUN. (For easy starting, be sure the control switch has been OFF long enough for the motor to come to a full stop.)

2. Close the separator blowdown valve when the generator steam pressure gauge-212 registers 100 lbs.
3. Open the separator blowdown valve several times for three to five second intervals during the first few minutes of operation.
4. Set the water by-pass regulator-111 to the required train line pressure gauge-224.
5. After the trainline is coupled, open the remote control trainline shutoff valve-7 by depressing the reset lever-7a. Then open the stop and check valve-15 gradually.

**NOTES:**

1. Check the return water flow after the steam generator has settled down to a steady output; the return water flow indicator—218 should cycle from 4 to 12 times a minute.
2. If the steam generator does not start or function properly, check all valves to see that they are open or closed as indicated in the schematic piping diagrams or in "Before Starting" instructions.
3. The steam generator should come up to full operating pressure in about two to five minutes; it may take 10 or 15 minutes to build up the required operating steam pressure in the trainline.

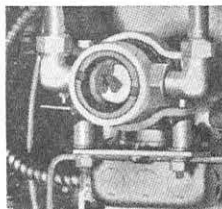

Fig. 9. Return Water Flow Indicator.

**STANDBY OPERATION**

During freezing weather, steam generators equipped with this protective feature should be operated in STANDBY position when the locomotive is in freight service. In STANDBY, warm water (not steam) is circulated through the system; to prevent damage to the steam generator, water tanks and piping.



Fig. 10. Control Switch Standby Position.

**STEAM GENERATORS**

1. Follow normal FILL and START procedures outlined above.
2. Set water by-pass regulator-111 for maximum pressure.
3. Close stop and check valve-15.
4. Open return line valve (standby)-56 and make sure steam admission valve to radiation-10 is open.
5. Turn control switch-102 to STANDBY.

**CAUTION:** To prevent loss of water while in STANDBY, make sure the following valves are not opened:

- 2—Coil blowdown
- 12—Separator blowdown
- 15—Stop and check valve

**TO RETURN TO PASSENGER OPERATION FROM STANDBY**

1. Close return line valve (standby)-56.
2. Follow normal procedure "TO START STEAM GENERATOR" outlined above.

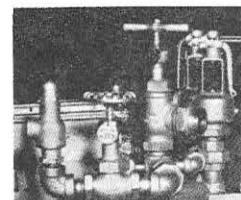

Fig. 11. Return Line Valve (Standby).

**NOTE:** Be sure to open the separator blowdown valve several times for three to five second intervals during first few minutes of operation.

**RUNNING ATTENTION**

1. Open the separator blowdown valve-12 for five seconds at least once every hour. (Except when in Standby operation.)
2. During stops, turn the handle on the fuel filter-206. At the same time, turn the handle on the treatment injector filter-225, where this method of water treatment is used.

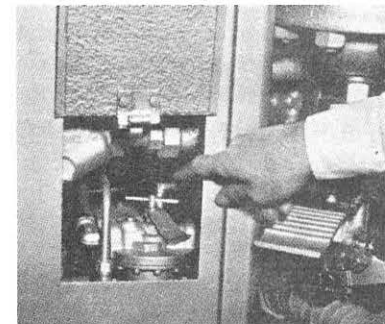

Fig. 12. Fuel Filter Handle.

### TO SHUT DOWN THE STEAM GENERATOR

For short stops it is necessary only to close the stop and check valve-15; the fire will cycle off and on, and maintain operating pressure in the steam generator. For terminal stops, proceed as follows:

1. Press the remote control trainline shutoff button and close the stop and check valve-15.
2. Set the water by-pass regulator-111 to maximum output. When the generator steam pressure gauge-212 registers 200 lbs. turn the control switch-102 to OFF.
3. Open the coil blowdown valve-2. When the generator pressure drops to 75 lbs. close the valve.
4. Open the separator blowdown valve-12 and blow down the steam separator-221 with the remaining pressure. Close the separator blowdown valve.
5. Fill the coils with water.
6. Close the atomizing air shutoff valve-1 and open the main switch.

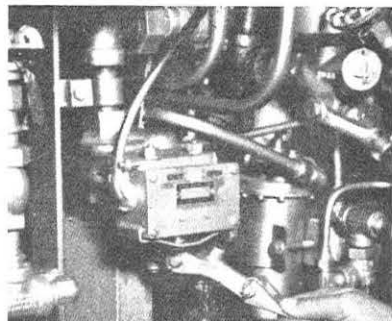

Fig. 13. Coil Blowdown Valve, "Open".

**NOTE:** When starting, do not omit draining the steam separator, opening the fill-test valve, and again filling the steam generator with water. If the coils are already full, it will only take a moment for water to discharge from the fill-test valve.

### FREEZING WEATHER PRECAUTIONS

The inlet valve-10 to the radiation-217 should be opened when operating during severe weather.

If a locomotive with a multiple installation does not have

### STEAM GENERATORS

all of its steam generators in operation, open layover valve-6 and inlet valve-10 to the radiation on idle steam generators; be sure that separator blowdown valve-12 and coil blowdown valve-2 are closed.

If a locomotive is left standing out of service, operate one of the steam generators or make a connection to the yard steam line; make certain layover valve-6 and inlet valve-10 to the radiation are open.

If no steam at all is available, thoroughly drain the steam generator. Open the drain valves-20 and 22, the water pump test valve-18, the coil blowdown valve-2, the separator blowdown valve-12 and the coil shut-off valve-3. Break the pipe connections where necessary to completely drain the piping. Turn the water pump by hand to clear it of water, or blow it out with compressed air. Remove the cover of the water treatment or water strainer tank-234 and make sure it is drained.

For DSK and early model OK units where valve-6 admits steam to top of separator instead of into inlet side of coil—Open coil blowdown valve-2, layover valve-6 and inlet valve-10 to the radiation side on idle units; *CAUTION: Layover valve-6 must be closed when trainline shutoff valve-7 is closed to uncouple the trainline.*

**CAUTION:** On early models units having valve-28, the steam valve feeding valves-10 and 6 must be closed if valve-28 is open before uncoupling the trainline for any reason.

### TROUBLE SHOOTING

If one of the protective switches (magnetic overload relay, coil blowdown switch, stack switch high temperature contacts or low temperature contacts, outfire relay, air cut out switch contacts; and on the 4740 units, the steam temperature limit control high contacts and the two control circuit breakers) operate to shut down the steam generator; the alarm will ring and the "Boiler Off" signal will flash.

Turn the control switch-102 to OFF and use the following instructions as a guide in locating the trouble.



### Motor and Burner Shut Down During Operation

1. *Blown fuses OK series (except 4740) and DSK series:* The alarm will not ring and the instrument lights will go out. The main fuse (or circuit breaker) is generally located in the low voltage cabinet of the locomotive. Check this fuse, and check the control fuses in the steam generator control cabinet. The OK series (except 4740) of steam generators has a test lamp and fuse clips wired inside the control cabinet. Use this fuse test clip and test lamp to check the fuses.

*Open circuit breakers OK-4740 series only:* The alarm rings and instrument lights go out, if control circuit breakers are open. If the main fuse (or circuit breaker) is out, the alarm will not ring. Reset, and start as usual.

2. *Overload reset button 106 "out":* The alarm will ring; the instrument lights will remain on. Turn the control switch-102 OFF; check for hot blower-202 or water pump-230 bearings, over-heated fuel pump and for poorly adjusted pulley belts. (On 4740 units, check for over-heated gear drive assembly.) On OK units (except 4740's) check the setting of the belt tension adjuster. Push the overload reset button "in."
3. *Stack switch-109 reset button "out" OK series (except 4740) and DSK series:* The high temperature contacts in the stack switch are open; the alarm will ring and the instrument lights will remain on. Turn the control switch-102 to OFF; open the separator blowdown valve-12 and drain the steam separator-221. Close the separator blow-

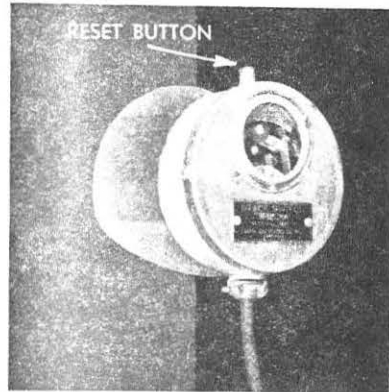

Fig. 14. Stack Switch.

down valve, push in the stack switch reset button, refill the coils with water, and then start the steam generator.

*Stack switch-109 reset button "out" OK-4740 series only:* Alarm rings and instrument lights remain on. Open the separator blowdown valve-12 and turn control switch-102 to FILL. When water begins to flow from this valve, turn control switch OFF, close the valve, push in the stack switch reset button, and restart the steam generator.

4. *Coil blowdown valve-2 partially open:* Alarm rings and instrument lights remain on. Turn the control switch-102 OFF, be sure that the locking pin on the coil blowdown valve handle is properly seated in closed position, and then restart in usual manner.
5. *Steam temperature limit control-110 reset button "out" OK-4740 series only:* Alarm rings and instrument lights remain on. Open separator blowdown valve-12, and turn control switch to FILL. When water begins to discharge from the open valve, turn control switch OFF, close the valve, push in the reset button, and start as usual.
6. *Air switch-101 contacts open OK-4740 series only:* Alarm rings and instrument lights remain on. Turn control switch-102 OFF. Be sure air admission valve is fully open. Clean the strainer screen in atomizing air line and drain the air pressure regulator-100. If the low atomizing air pressure persists, tighten the adjusting screw at the top of the air pressure regulator to increase the pressure. When air pressure is restored, start the steam generator as usual.

### Motor Starts But Burner Does Not

If the fire fails to light, the low temperature contacts on the stack switch-109 will not close, and after a 45 second time delay the outfire relay will open the circuit to shut down the steam generator. The alarm will ring and the instrument lights will remain on. Turn the control switch-102 OFF and check the following list for possible causes for the burner failure.

1. *Ignition Failure:* No spark visible through the peep sight glass, or the spark is of low intensity; be sure that the spark plug electrodes are clean, and correctly spaced.

Check the ignition fuses—on OK series (except 4740's) use the test lamp and clips installed in the control cabinet for that purpose.

Check the rotary converter circuit breaker-115 (OK-4740 series only) which may be open; reset to close it.

Tighten loose cable connections and replace chafed or broken wire which may be breaking or grounding the circuit.

2. *Low atomizing air pressure-201 OK series (except 4740) and DSK series:* The air switch-101 on OK units opens and breaks the circuit to the fuel solenoid valve-104, which then stops the flow of fuel to the sprayhead-105. On DSK units, low air pressure will fail to lift the diaphragm in the fuel sprayhead-105; the needle valve remains closed and prevents the admission of fuel to the firepot.

Be sure the air admission valve-1 is fully open. Clean the strainer screen in the atomizing air line and drain the atomizing air pressure regulator-100. If the low atomizing air pressure persists, tighten the adjusting screw at the top of the air pressure regulator to increase the atomizing pressure.

3. *Low fuel manifold pressure-208:* Turn the handle on the suction line fuel filter-206 several times. A slight suction leak may cause the manifold pressure to build up slowly; put the control switch-102 on FILL to bleed the fuel line and bring the manifold pressure up to normal.
4. *Low fuel nozzle pressure-207:* Lack of water causes the servo-fuel control-108 to limit the supply of fuel entering the nozzle. (If the water supply is almost completely stopped, the cam plate may come down far enough to actuate the cutout switch on the servo and close the fuel solenoid valve-104).

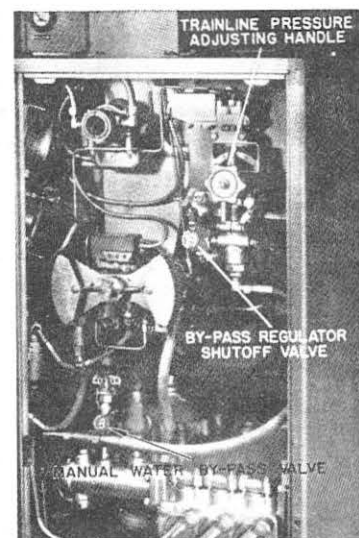

Fig. 15. Feed Water Controls OK-4630

Be sure that the pump belts (not on 4740 units) have proper tension, the water pump test valve-18 is closed, the cover on the water treatment or strainer tank-234 is tight, the three-way washout valve-17 is fully open, and that the drain valves-20 and 22 are tightly closed.

Open and close the water by-pass regulator-111 adjusting handle several times to free the regulator from possible sediment. If the water pressure gauge-229 still registers low, close the water by-pass regulator shutoff valve-19. This closes the water by-

pass line and permits all of the feed water to flow to the servo-fuel control-108; the steam generator will start at once if the by-pass regulator is causing the trouble. Set and manually regulate the trainline steam pressure by adjusting the manual water by-pass valve-8.

High feed water temperature or leaky water line connections may cause the water pump-230 to become air or vapor bound. Violent fluctuation of the servo fuel control-108 or water pressure gauge needle indicates this condition. Tighten leaky water line connections and bleed the line by opening the water pump test valve-18. Allow water to flow from this valve until no air or vapor bubbles are evident in the water.

### Irregular Trainline Pressure

1. *Burner cycles off and on:* Insufficient water delivery causes the steam generator to run in superheat; the steam temperature limit control-110 operates to protect the coils against overheating.

OK-4616, OK-4625, OK-4630, OK-4635, OK-4740, DSK-4530

2. **Safety valves blow:** Shut down the steam generator. Lower the trainline pressure setting on the adjusting handle of the water by-pass regulator-111 and start the steam generator again. If the safety valves-107 continue to pop, close the water by-pass regulator shutoff valve-19 and manually regulate the trainline steam pressure by opening and adjusting the manual water by-pass valve-8.

**NOTE:** On OK-4740 series only: Repeated cycling, which would cause superheating, may cut out high temperature contacts of steam temperature limit control shutting down generator and sounding alarm.

### REMOTE CONTROL EQUIPMENT

The remote controls are located on the fireman's side of the locomotive cab. Push-button switches operate the separator blowdown valve-12 and the remote control trainline shutoff valve-7.

The remote control trainline shutoff valve-7 can be closed from the cab; it must be opened manually, however. Depress the reset lever-7a on the trainline shutoff valve-7 to the position marked "open".

### ITEMS TO REPORT

Faulty operation of the steam generator for any reason such as:

1. Discharge of water from water relief valve-112.
2. Excessive stack temperature.
3. Fluctuation of the fuel manifold pressure.
4. Frequent cycling of the burner.
5. Water flow indicator not cycling.
6. Water by-pass regulator inoperative.
7. Insufficient steam output.

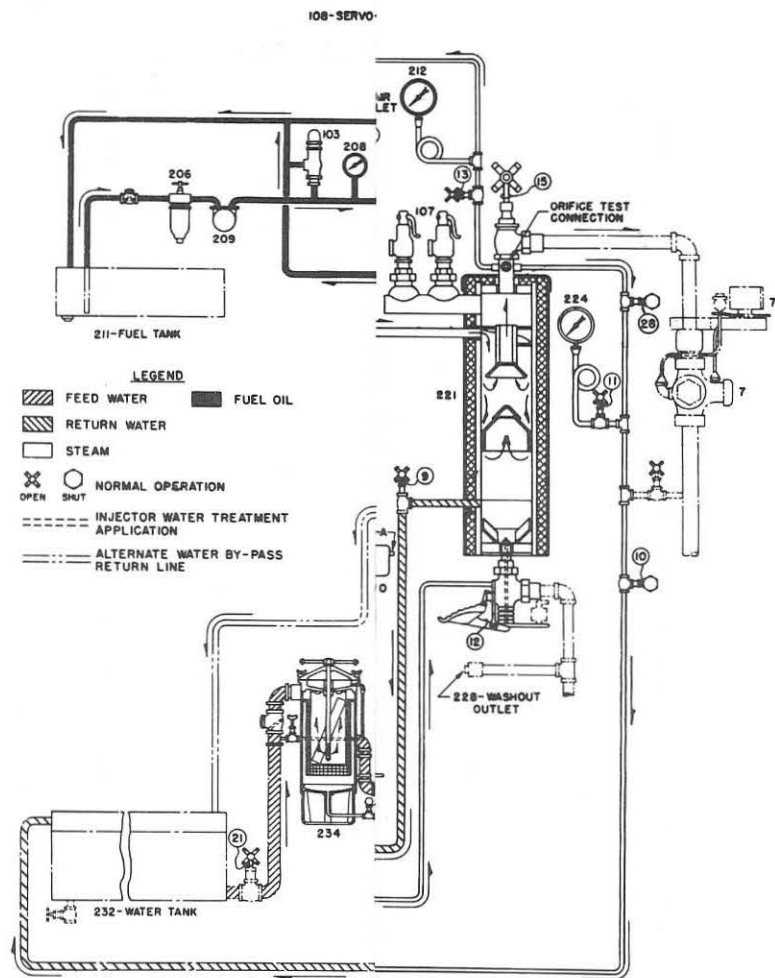

### KEY TO IDENTIFI for Steam Generators

- 109—Stack Switch
- 110—Steam Temperature Limit Control
- 111—Water By-Pass Regulator
- 112—Water Pressure Relief Valve
- 115—Converter Circuit Breaker
- 116—Line Circuit Breaker Reset (positi
- 117—Line Circuit Breaker Reset (negati
- 118—Main Switch
- 120—Aquistat (standby)
- 121—Relief Valve (standby)
- 122—Fuel By-Pass Solenoid Valve (Stand

### APPURTENANCES

- 200—Atomizing Air Strainer
- 201—Atomizing Air Pressure Gauge
- 202—Blower
- 203—Damper

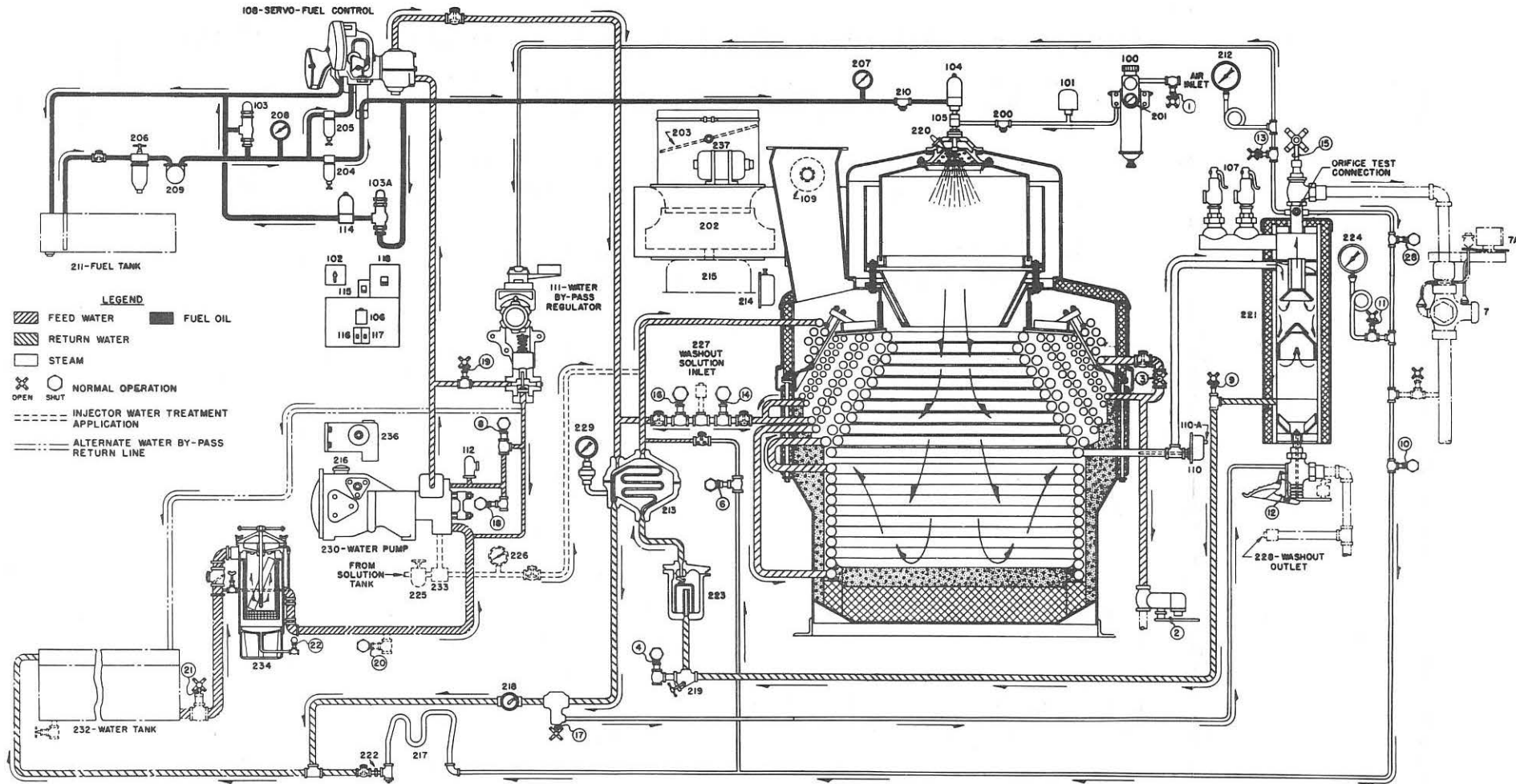

SCHEMATIC PIPING DIAGRAM, OK-4740 SERIES VAPOR

STEAM GENERATOR

**KEY TO IDENTIFICATION SYMBOLS For Schematic Piping Diagram OK-4740 Series Vapor Steam Generators**

- 109—Stack Switch
- 110—Steam Temperature Limit Control
- 111—Water By-Pass Regulator
- 112—Water Pressure Relief Valve
- 115—Converter Circuit Breaker
- 116—Line Circuit Breaker Reset (positive)
- 117—Line Circuit Breaker Reset (negative)
- 118—Main Switch
- 120—Aquastat (standby)
- 121—Relief Valve (standby)
- 122—Fuel By-Pass Solenoid Valve (Standby)

**APPURTENANCES**

- 200—Atomizing Air Strainer
- 201—Atomizing Air Pressure Gauge
- 202—Blower
- 203—Damper

- 204—Fuel Filter (Pressure line)
- 205—Fuel Filter (servo actuating line)
- 206—Fuel Filter (Suction line)
- 207—Fuel Nozzle Pressure Gauge
- 208—Fuel Pressure Gauge (At fuel pressure regulator)
- 209—Fuel Pump
- 210—Fuel Strainer
- 211—Fuel Tank
- 212—Generator Steam Pressure Gauge
- 213—Heat Exchanger
- 214—Ignition Transformer
- 215—Motor
- 216—Oil Filter Cap
- 217—Radiation
- 218—Return Water Flow Indicator
- 219—Return Water Strainer
- 220—Spark Plug
- 221—Steam Separator

- 222—Orifice Nipple (Radiation)
- 223—Steam Trap (Return water line)
- 224—Trainline Steam Pressure Gauge
- 225—Treatment Injector Filter
- 226—Treatment Injector Gauge
- 227—Washout Solution Inlet
- 228—Washout Solution Outlet
- 229—Water Pressure Gauge
- 230—Water Pump
- 232—Water Tank
- 233—Water Treatment Injector Pump
- 234—Water Treatment Tank (Strainer tank only if injector system is used)
- 235—Strainer Tee
- 236—Worm Drive
- 237—Rotary Converter
- 240—Circulating Pump (standby)

# STEAM



# GENERATOR

## DURING NORMAL OPERATION

{ All cross bar handle valves have odd numbers and must be OPEN.  
All round handle valves have even numbers and must be CLOSED.

**WARNING: DO NOT START STEAM GENERATOR  
UNLESS THE COILS ARE FILLED WITH WATER.**

### TO FILL

1. Open atomizing air shutoff valve - 1, fill-test valve - 4, and separator blowdown valve - 12 to drain separator. Close separator blowdown valve.
2. Check overload - 106 and stack switch - 109 reset buttons.
3. Close main switch and turn control switch - 102 to FILL.
4. Check ignition spark - 220 and ALL valves.
5. Turn control switch OFF when water flows from fill-test valve - 4. Close fill-test valve.

### TO START

1. Open separator blowdown valve - 12. Turn control switch - 102 to RUN.
2. Close separator blowdown valve when generator pressure gauge - 212 registers 100 lbs.
3. Blow down the steam separator - 221 several times for 3 to 5 second intervals during first few minutes of operation.

4. Set water by-pass regulator - 111 to the required trainline pressure. Gauge - 224.
5. After trainline is coupled, depress reset lever on automatic trainline shutoff valve - 7 and open stop and check valve - 15 on steam separator.

### TO STOP

For short stops close stop and check valve - 15 only; the unit will cycle. For terminal stops proceed as follows:

1. Close stop and check valve and build generator pressure up to 200 lbs.
2. Turn control switch - 102 OFF. Open coil blowdown valve - 2. When pressure drops to 75 lbs. close the valve. Open separator blowdown valve - 12. Close when separator is completely drained.
3. Refill the coils, turn control switch OFF. Close atomizing air valve - 1 and open main switch.

(Identification numbers refer to symbols on color schematic drawing in locomotive or operator's manual)

# Schematic Piping Diagram, OK-4625 Series Vapor Steam Generator.

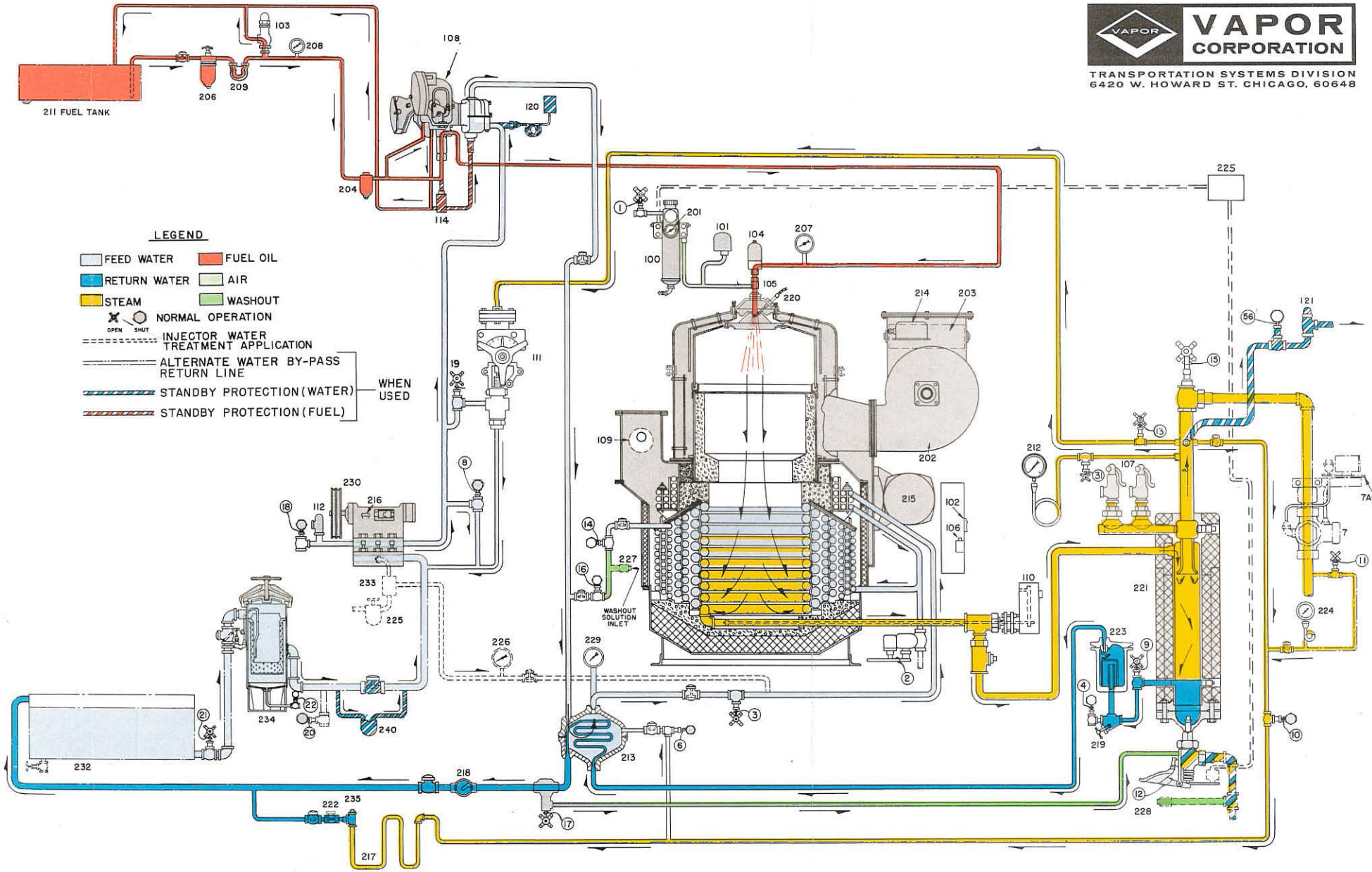

**CAUTION: DO NOT START THE STEAM GENERATOR UNLESS COILS ARE FILLED**

# KEY TO IDENTIFICATION SYMBOLS

## For Schematic Piping Diagram

### OK-4625 Series Vapor-Clarkson Steam Generator

#### VALVES

Valves designated by odd numbers are fitted with cross type handles, and must be OPEN during normal operation of the steam generator; valves designated by even numbers are fitted with standard round handles, and must be CLOSED during normal operation of the steam generator. This applies only to the OK series steam generators.

The following valves must be CLOSED during normal operation of the steam generator:

- 2—Coil Blowdown Valve and Switch
- 4—Fill-Test Valve
- 6—Layover Connection Shutoff Valve
- 8—Manual Water By-Pass Valve
- 10—Steam Admission Valve to Radiation (Open in cold weather)
- 12—Steam Separator Blowdown Valve
- 14—Washout Inlet Valve
- 16—Washout Inlet Valve
- 18—Water Pump Test Valve
- 20—Water Suction Drain Valve
- 22—Water Treatment Tank Drain Valve
- 56—Return Line Valve (Standby)

The following valves must be OPEN during normal operation of the steam generator:

- 1—Atomizing Air Shutoff Valve
- 3—Coil Shutoff Valve
- 7—Remote Control Trainline Shutoff Valve
- 7a—Reset Lever
- 9—Return Water Outlet Valve
- 11—Steam Admission Valve to Trainline Pressure Gauge
- 13—Steam Admission Valve to Water By-Pass Regulator
- 15—Stop and Check Valve (Closed during start or shut down procedure)
- 17—Three-Way Washout Valve
- 19—Water By-Pass Regulator Shutoff Valve
- 21—Water Supply Stop Valve

#### CONTROLS

- 100—Atomizing Air Pressure Regulator
- 101—Atomizing Air Switch
- 102—Control Switch
- 103—Fuel Pressure Regulator

- 104—Fuel Solenoid Valve
- 105—Fuel Spray Head
- 106—Overload Reset Button, Motor
- 107—Safety Valves
- 108—Servo-Fuel Control and Switch
- 109—Stack Switch
- 110—Steam Temperature Limit Control
- 111—Water By-Pass Regulator and Switch
- 112—Water Pressure Relief Valve
- 120—Aquistat (standby)
- 121—Relief Valve (Standby)
- 122—Fuel By-Pass Solenoid Valve (standby)

#### APPURTENANCES

- 200—Atomizing Air Strainer
- 201—Atomizing Air Pressure Gauge
- 202—Blower
- 203—Damper
- 204—Fuel Filter (Pressure line)
- 206—Fuel Filter (Suction line)
- 207—Fuel Nozzle Pressure Gauge
- 208—Fuel Pressure Gauge (At fuel pressure regulator)
- 209—Fuel Pump
- 210—Fuel Strainer
- 211—Fuel Tank
- 212—Generator Steam Pressure Gauge
- 213—Heat Exchanger
- 214—Ignition Transformer
- 215—Motor Converter
- 216—Oil Filter Cap
- 217—Radiation
- 218—Return Water Flow Indicator
- 219—Return Water Strainer
- 220—Spark Plugs
- 221—Steam Separator
- 222—Orifice Nipple (Radiation)
- 223—Steam Trap (Return water line)
- 224—Trainline Steam Pressure Gauge
- 225—Treatment Injector Filter
- 226—Treatment Injector Gauge
- 227—Washout Solution Inlet
- 228—Washout Solution Outlet
- 229—Water Pressure Gauge
- 230—Water Pump
- 232—Water Tank
- 233—Water Treatment Injector Pump
- 234—Water Treatment Tank (Strainer tank only if injector system is used)
- 235—Strainer Tee
- 240—Circulating Pump (standby)



211 FUEL T



232